

COFFEE TABLES

CTR-120G

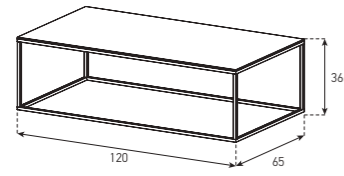

ES90D

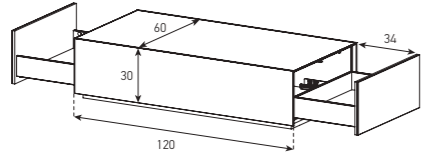

MAXI TRIPLE

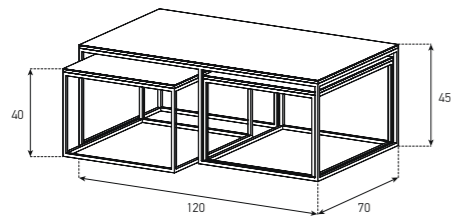

CT-SET 3

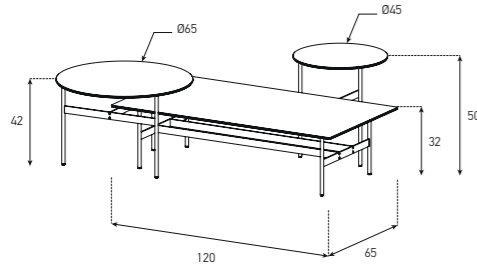

CT-SET4

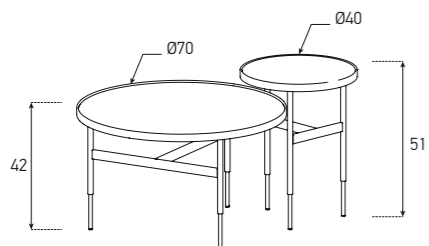

CTS-100G

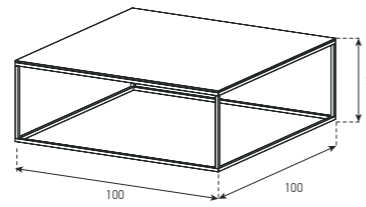

ES91D

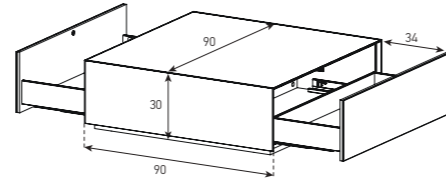

MAXI TRIPLE-A

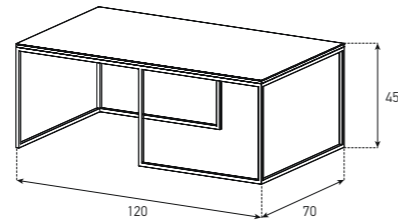

CT-SET3-A

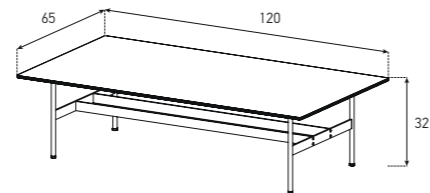

CT-SET4-A

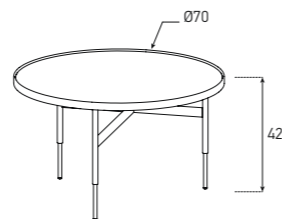

CT-SET 1

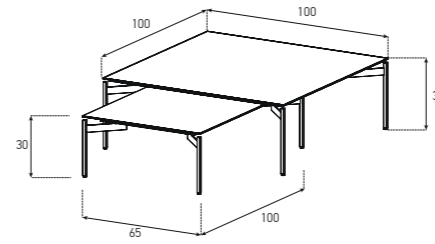

CT-SET1-A

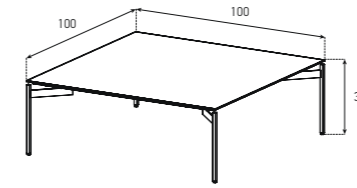

CT-SET2-BMR

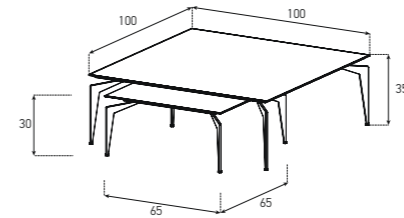

CTR-130C30

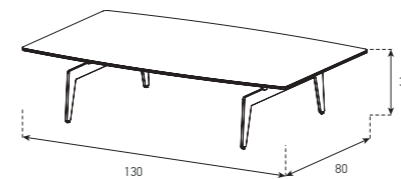

MAXI TRIPLE-B

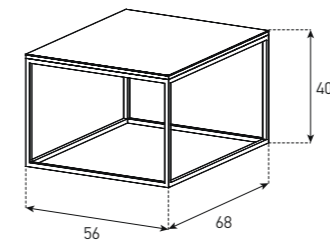

CT-SET2

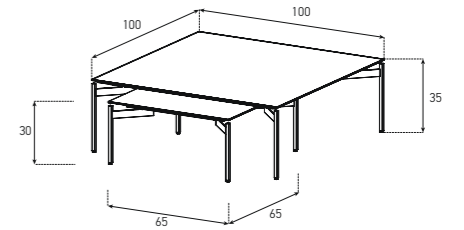

CT-SET1-BMR

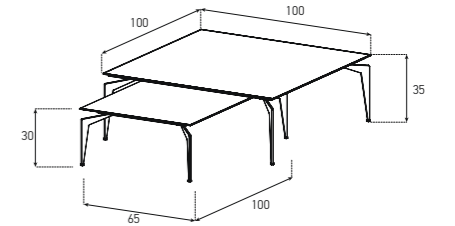

CT-SET1-BMR-A

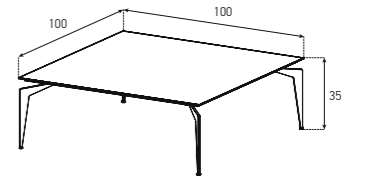

SABUL

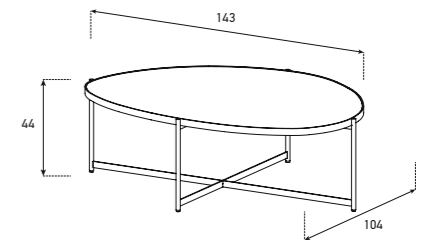

SIDE TABLES

TRIPLE

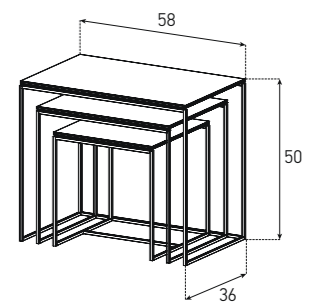

CT-SET2-B

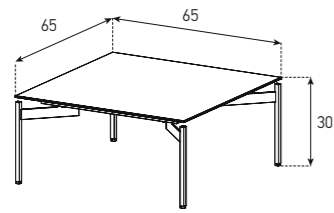

CT-SET2-BMR-B

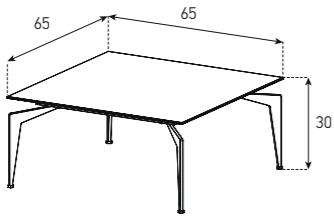

CT-SET3-B

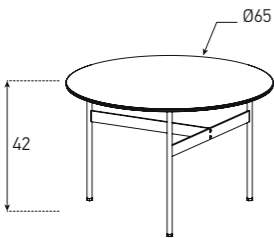

CT-SET4-B

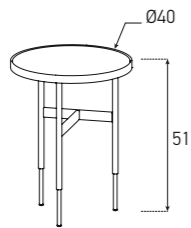

KL-49

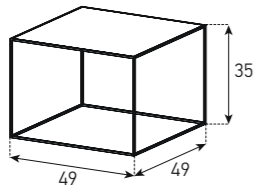

CT-SET1-B

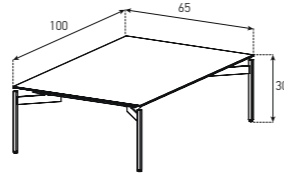

CT-SET1-BMR-B

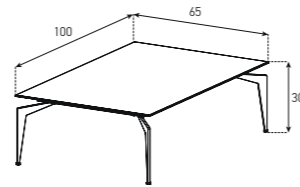

CT-SET3-C

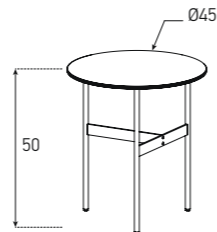

KL-42

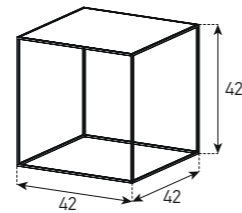

COFFEE TABLES AND SIDE TABLES
CODE SAMPLE

CTS-100G-WHT-GRY

1 2 3

1) Type :

2) Top Color & Decor : Page 68-71 "Category (A, A+ & F) "

3) Metal Leg Color : Page 68-71 "Category (D) "

Note : In case of set orders, encode different color and material preferences individually.

ES90D-WHT-WHT-CG2BLK

1 2 3 4 5

1) Cabinet Types

ES90D



ES91D

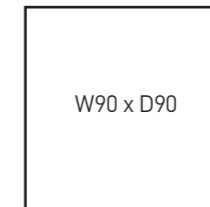

2) Cabinet Color & Decors : "Category (A, A+ & B) "

3) Door Color & Decors : "Category (A, A+, B, & F) "

4) Base Options :

2
(3,5cm Base)

CG2
(20cm Metal Cage)

5) Metal Leg Color : Page 68-71 "Category (D) "